

### A. J13011进水阀安装说明

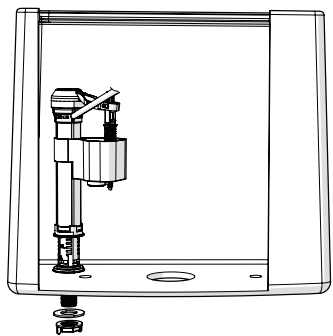

1. 将螺母和塑垫依次从进水阀上取下, 把带密封垫的进水阀插入水箱进水口, 转到适当角度后, 再依次放上塑垫, 旋紧螺母;

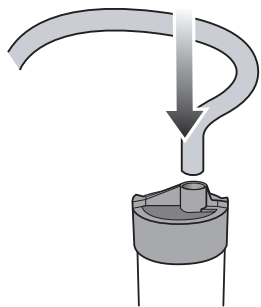

2. 将补水管接入排水阀的溢水管内;

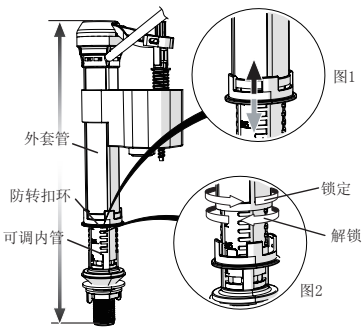

3. 安装好进水阀后, 向下拉动防转扣环 (图1) 此时按 (图2) 方向解锁外套管, 调整进水阀至适当高度, 再按 (图2) 方向锁定外套管, 向上扣紧防转扣环 (图1);

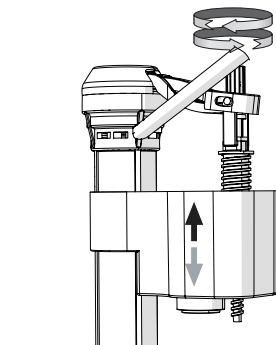

4. 完成进水阀高度调整后, 顺时针或逆时针旋转调节螺杆, 使外浮桶和内浮桶上下移动微调水位高低;

### B. P206分体排水阀安装说明

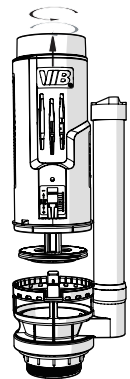

1. 将本体从底座上取下;

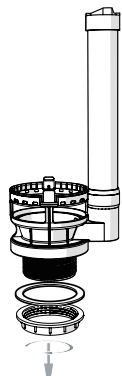

2. 将螺母和塑垫依次从底座上取下;

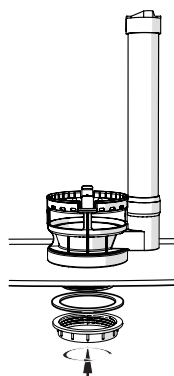

3. 将带胶垫的底座放入水箱的安装孔, 再依次放上塑垫, 旋紧螺母;

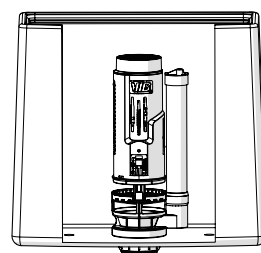

4. 在安装好底座的水箱上对准放入排水阀本体, 用力压入直至底座两边卡扣扣住排水阀本体, 将排水阀旋转至适当位置;

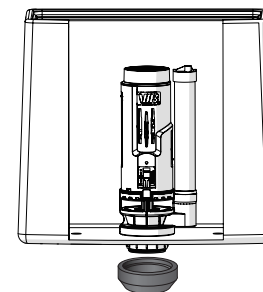

5. 在水箱底部的底座上套上发泡安装胶垫;

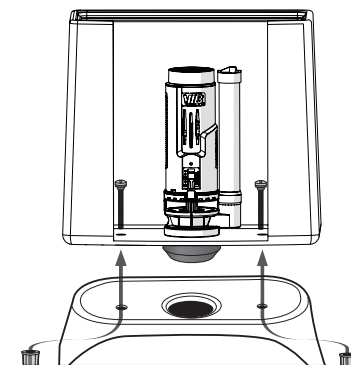

6. 安装好发泡安装胶垫的水箱放在分体马桶的安装孔上, 用固定螺栓锁住;

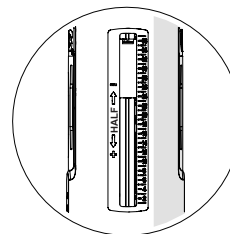

1. 标识有HALF的为半排调节窗口, 用来调节半排水位高低;

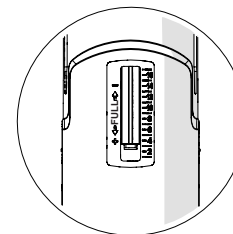

2. 标识有FULL的为全排调节窗口, 用来调节全排水位高低;

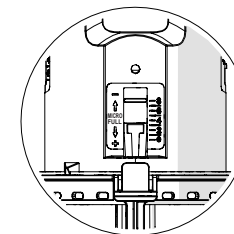

3. 标识有Micro FULL的为全排微调窗口, 用来调整全排水桶最低时的全排精确水位;

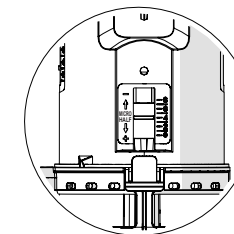

4. 标识有Micro HALF的为半排微调窗口, 用来调整半排水桶最低时的半排精确水位;

### C. 按钮安装说明

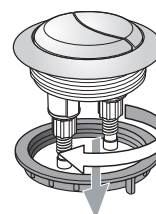

1. 将螺母从按钮上旋下;

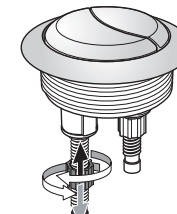

2. 旋开螺杆固定螺母, 顺时针或逆时针调节螺杆至适当位置再旋紧螺杆固定螺母;

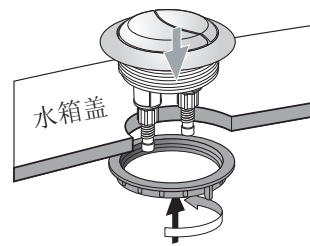

3. 将按钮本体放入水箱盖的安装孔中, 旋紧螺母;

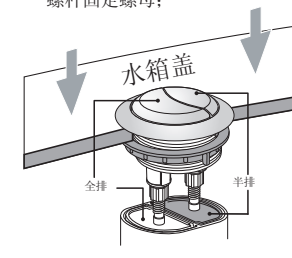

4. 将水箱盖安装到水箱上, 注意按钮的全半排按键需对应排水阀的全半排按键;